



PMA Cable Protection for rail vehicles and rail infrastructure

OUR VALUES

Customer satisfaction is our focus

We are a market leader in the design, manufacture and supply of superior flexible cable protection systems for a range of demanding applications.

Excellence in cable protection solutions

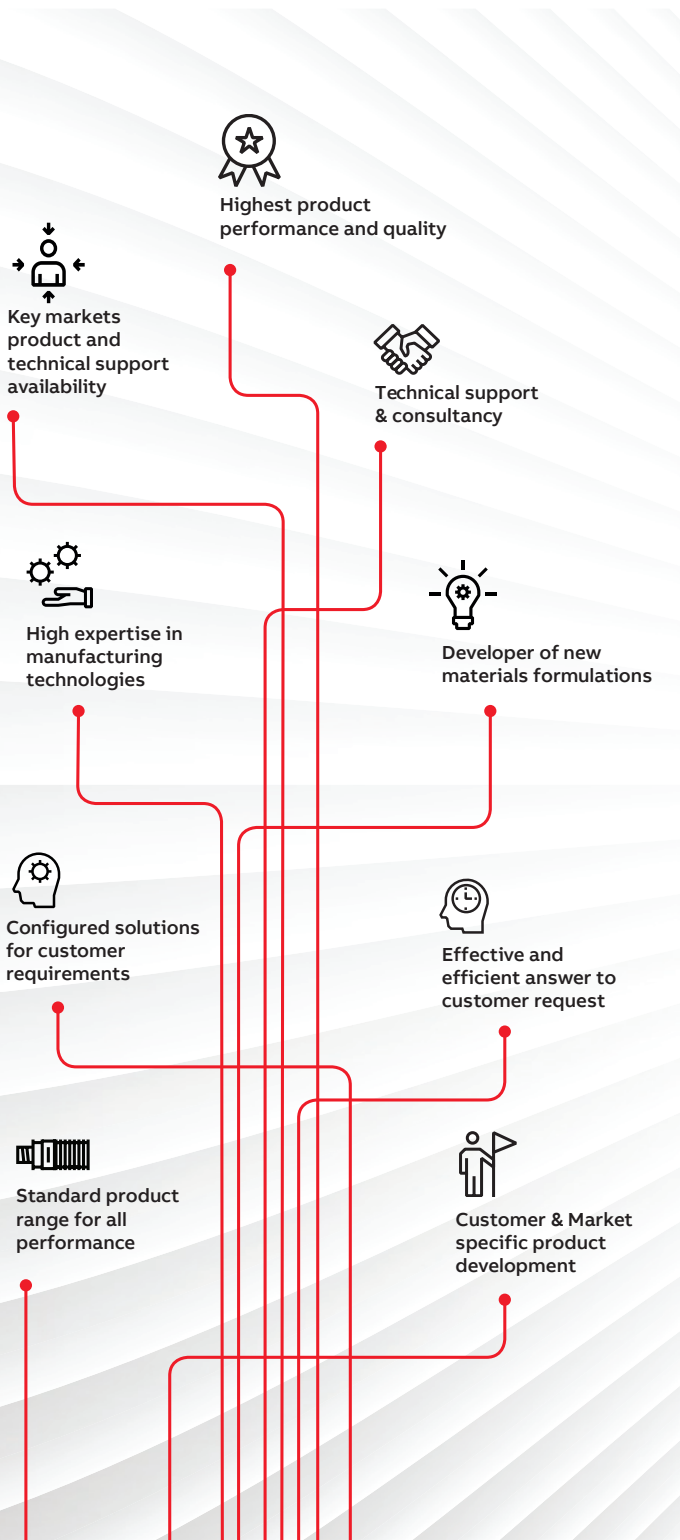

Table of contents

004–005	From pioneer to market leader
006–007	Rolling stock
008–009	Rail infrastructure
010–011	Rail customer success stories
012–013	PMA Conduits for the Rail industry
014–015	PMAFIX Pro fittings
016–017	PMAFIX IP66, IP68 (IP69) fittings
018–019	Special connectors for the Rail industry
020–021	Fire barrier solutions for the railway industry
022	Modular support system
023	Multilayer solutions for the rail industry
024–025	PMA's tested and certified excellence
027	Further information

From pioneer to market leader

Highest performance, reliability and safety in cable protection for the Rail industry

ABB has been developing, producing, and selling top-quality PMA cable protection systems since 1975. Our high-quality Swiss products have rapidly earned us an excellent reputation worldwide and established us as the market leader.

Our range of more than 6,500 products gives customers the protection they need in railway applications worldwide, where power and data cables require dependable protection.

Rail vehicles/Rail infrastructure

PMA products from ABB have proven their dependability in railway construction projects around the world.

This is the reason why large corporations including Siemens, Alstom, Bombardier, PESA, CRRC, Deutsche Bahn, and SNCF have chosen us as supplier over a period of many years.

Our special railway engineering product line provides protection and safety on signalling systems, couplings, trucks, intercar connections, and gangways, as well as roof, and underfloor equipment.

The range of applications is very extensive. PMA products contribute to the safe operation of trams, locomotives, freight cars, high-speed trains, and even roller coasters.

Unique benefits of PMA products from ABB

Service to the customer is what motivates us. In addition to series production, PMA can build fittings and conduits to meet individual requirements as a special service to our customers.

- A safe, reliable system that is easy to install
- High system connection strength
- High conduit retention force and resistance to vibration
- Ingress protection conforming to recognised test methods



We use **QR codes** in this brochure to provide more information and technical details are available on our website. Simply use the camera of your smartphone to scan the code.





Worldwide recognitions

All PMA products are rigorously tried and tested to meet the demands of the rail industry worldwide.



Rolling stock

PMA products are used in an extremely wide range of rail applications

Fire barrier solutions from PMA cable protection

PMA cable protection solutions on bogies, couplings and intercar jumper connections

5

A 3D cutaway rendering of a rail vehicle interior, showing the underfloor equipment and cable management system. The image highlights the use of PMA cable protection solutions, including fire barriers, on bogies, couplings, and intercar jumper connections. A red circle with the number '5' is placed over a specific component in the lower-left area of the cutaway.

PMA cable protection solutions on the roof top

1

4

3

2

PMA cable protection solutions in passenger zones

Under carriage PMA cable protection solutions



— Smartphone for detailed product information.



Rail infrastructure

Better security for track-related installations

PMA cable protection solutions for connections to high-voltage rails

5

3

PMA cable protection solutions for rail tunnel applications

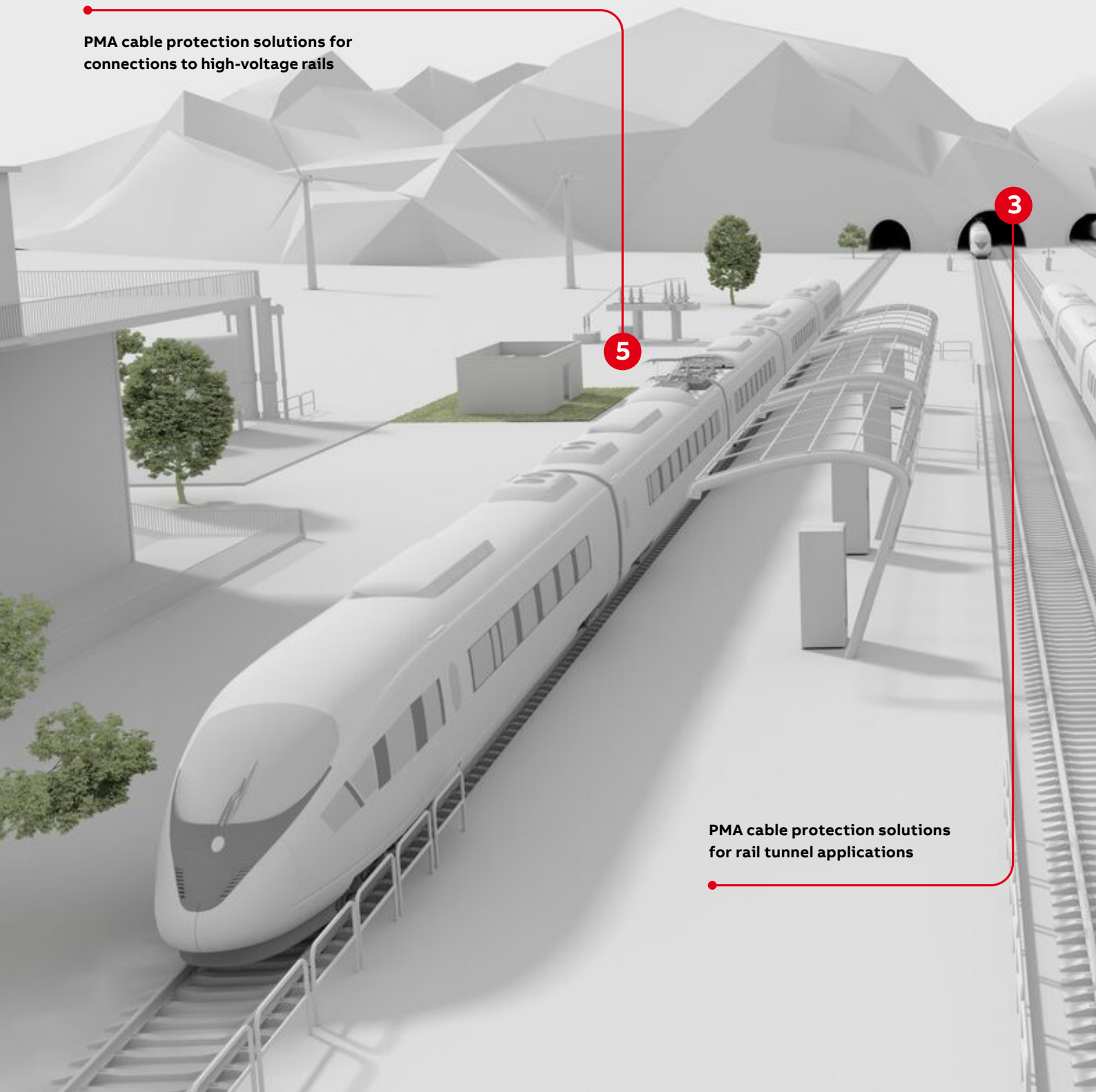

PMA Cable protection solutions for passenger information applications

PMA Cable protection solutions for signal and high-voltage installations

2

4

PMA Cable protection solutions for railtrack switches, wheel sensors and points installations

1



— Smartphone for detailed product information.



Rail customer success stories with PMA cable protection solutions



Gotthard Tunnel Case Study

PMA Flexible Cable Protection Solutions for the longest and deepest railway tunnel in the world.

ABB has been at the forefront of technological progress in Switzerland and around the world since 1891 – from the efficient production of electrical energy, to enhancements to industrial productivity, right through to sustainable mobility.



Rhaetian Railway (RhB) Case Study

PMA Cable Protection Solutions 'developed to meet the most stringent requirements for rail operations in breathtakingly beautiful mountainous regions'.

The Rhaetian Railway (RhB) has relied on ABB PMA's well-proven cable protection solutions for over ten years – It's because only the best and the most reliable materials are worth considering for the most stringent demands.



Efficient Plug-and-Play Case Study

PMA cable protection solutions for safe and reliable communication solutions for rail traffic.

Communication is paramount: PMA cable protection products from ABB are assisting HUBER+SUHNER with a smart cable protection solution for a project to replace the antennas in trains operated by Swiss Federal Railways (SBB).



Berlin S-Bahn Case Study

PMA Cable Protection for Local Transport provides safe cable protection solutions for the 1.5 million passengers of the Berlin S-Bahn.

ABB PMA and GIMOTA AG have helped the Berlin S-Bahn significantly improve the operational safety of its type 480 vehicles and made them more maintenance friendly by offering new solutions.



Light Rail Case Study

PMA Cable protection helps shape new trams on one of the world's oldest operating tram systems.

The Zagreb Electric Tram system and ABB forebear Brown Boveri were born in the same year – 1891. Today ABB is helping ZET put modern tram cars on the rails that are more comfortable and more reliable than ever before.

Customized Solution Case Study

PMA Cable protection can offer its rail customers customised solutions for virtually any task.

These solutions also benefit Bernmobil in Switzerland: The city's public transport operator, carries over 100 million passengers annually on its network of 5 tram routes, 3 trolley bus routes and 26 bus routes.

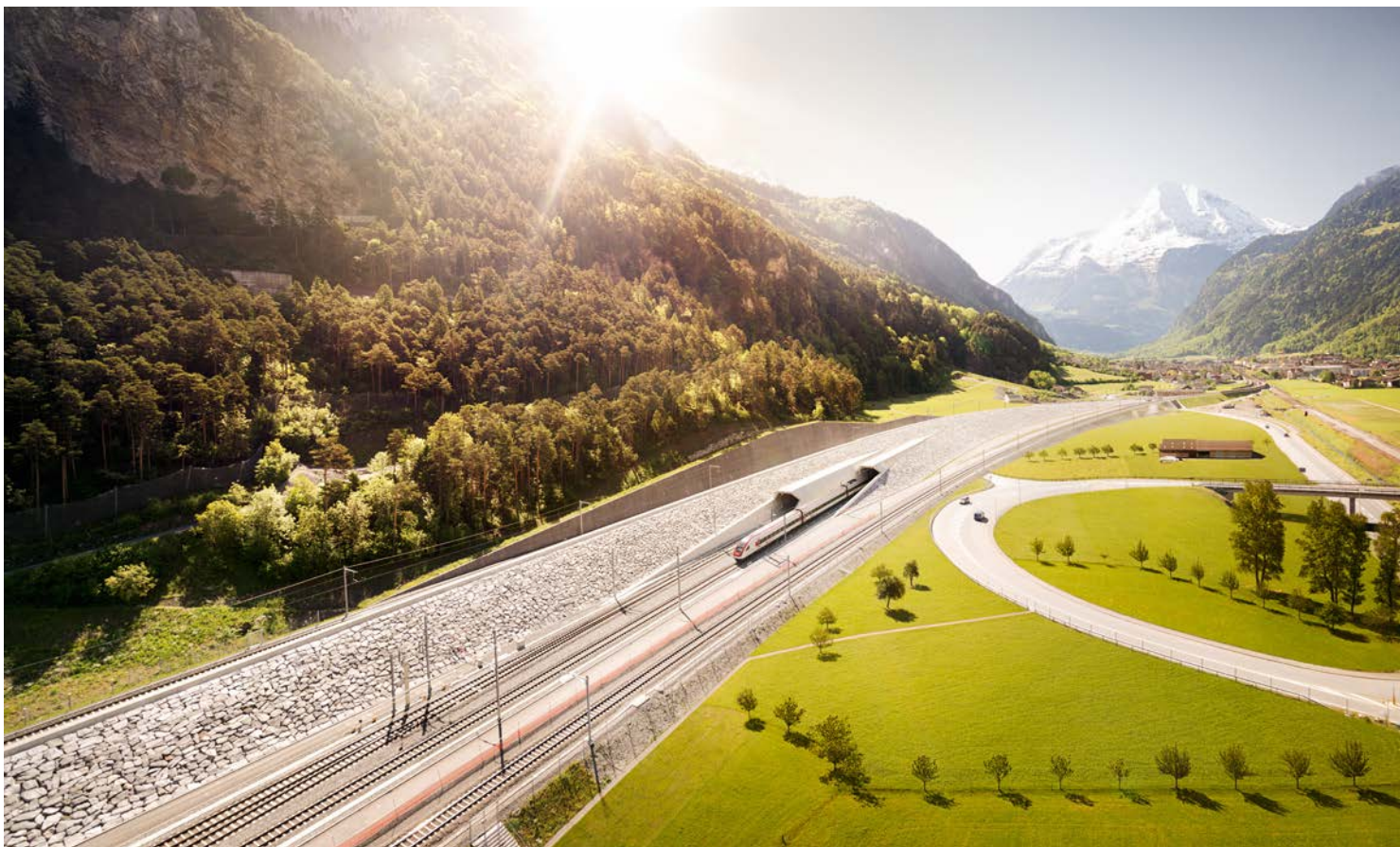

PMA Conduits for the Rail industry

Overview

We offer many types of conduit with different technical characteristics to serve the diverse requirements of various applications.

The product groups:

- PMAFLEX Pro
- PMAFLEX
- PMAFLEX PLUS
- PMAFLEX Multilayer
- PMA Divisible System
- PMA Smart Line
- PMA overbraided
- PMA overextruded

Many conduits are specially approved, e.g. CSA, UL Recognition, DNV, Lloyds, Bureau Veritas etc. All conduits are REACH and RoHS compliant.

Conduit sizes range from 6 mm to 125 mm Ø, from lightweight to heavyweight, and from pliable to highly flexible. PMA also offers slit and divisible conduits. Standard colours are black and grey.

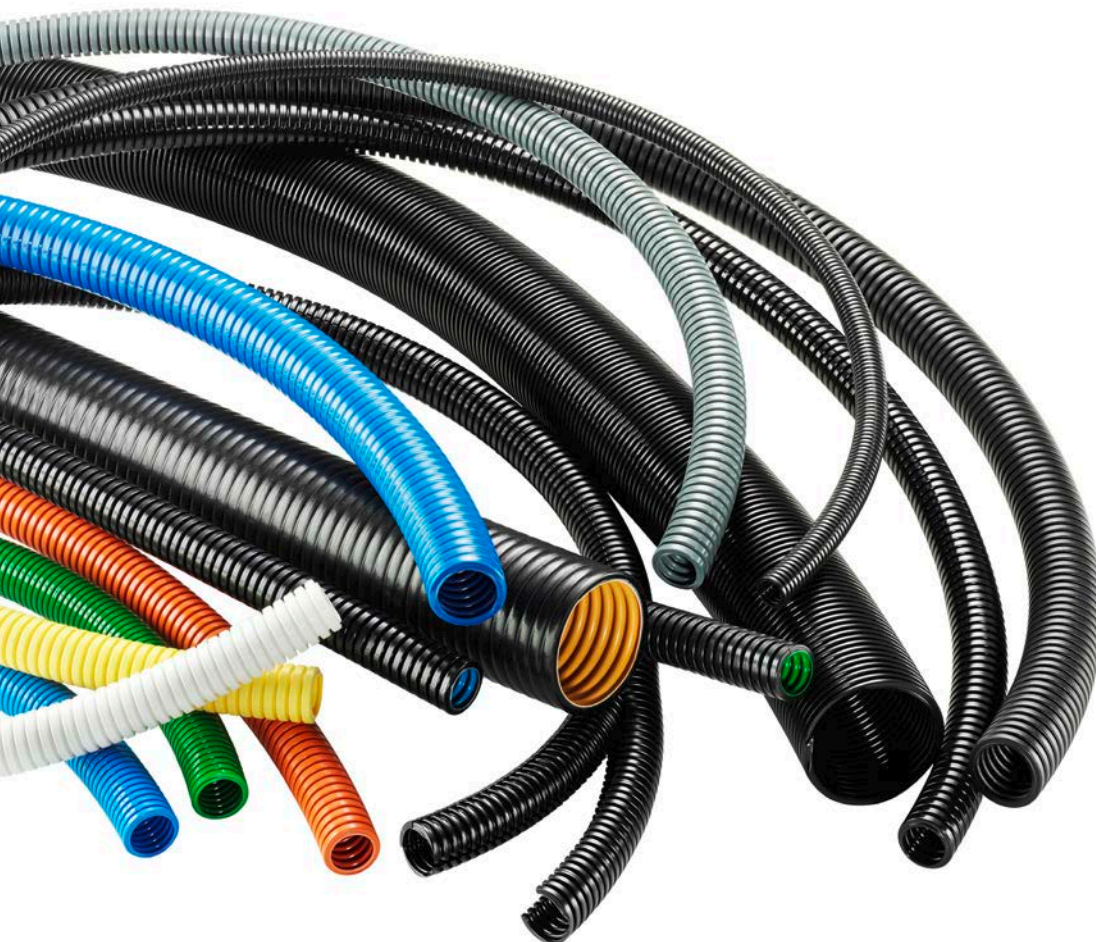

PMAFIX Pro

Introduction

Next generation cable protection. The extremely successful and technically proven PMAFIX System has been developed further to create the PMAFIX Pro product range.

The new generation fittings are the product of experience gained over many years in the most varied application areas. The PMAFIX Pro has two components, an outer body and an inner sealing element. The sealing element functions both as a seal and as a locking mechanism providing all ingress protection grades up to IP68 and IP69 even in applications where there is long term continuous movement. PMAFIX Pro is manufactured by using multiple component injection moulding process.

Key features

- Meets all ingress protection categories up to and including IP68 and IP69 also when the conduit connection is continually in motion
- Manufactured with newest 2-component injection moulding technology
- Fulfills highest international quality and standard requirements
- Intelligent safety locking mechanism
- Allows simple “push-in” installation of conduits
- Due to the integrated conduit supports conduit remains centralised with little deformation even when bent sharply directly at the fitting



PMAFIX Pro

General technical details

—
01 patent
—
02 Up to 100 bar

Material

- Fittings made from specially modified polyamide 6
- Threads made from nickel-plated brass or polyamide 6
- Sealings made from cross linked polyester elastomer
- Self-extinguishing
- Free from halogens, REACH + RoHS compliant
- Temperature range: -50°C to +105°C, short-term to +160°C

Characteristics

- Highest assembly reliability – the fitting only locks when the sealing element is fully inserted
- Highest operational safety assured through visual and acoustic correct assembly controls
- Excellent resistance to ultra violet rays and weathering
- Highest impact resistance through fully closed design
- Highest conduit pull out strength
- Vibration-proof connection to PMA conduits
- Fits conduit profiles – fine (T) and coarse (G)
- To avoid accidental opening, disassembling only possible with a screwdriver

—
01



—
02



—
IP68 + IP69

Static + dynamic

- Highest sealing through fully closed system also in highest dynamic applications
- Extra long ribbed sealing areas (cross linked material)
- 360° locking and sealing element shields against high pressure water jets (up to 100 bar)
- Content of delivery: Locking and sealing element and thread seal for male threads (O-Ring and/or flat gasket)

Connector series IP68 + IP69

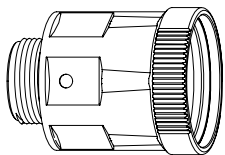

—
01

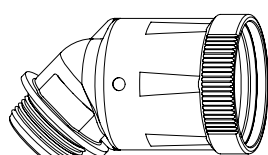

—
02

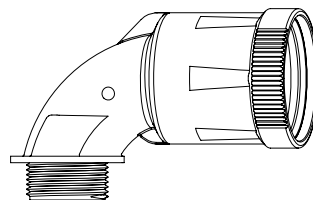

—
03

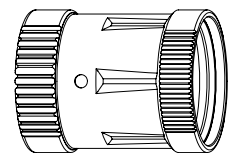

—
04

—
01 Straight (N)
—
02 45° elbow (A)
—
03 90° curved elbow (B)
—
04 Female thread (I)

PMAFIX IP66, IP68 (IP69)

General technical details

PMAFIX connectors. The designation PMAFIX describes a very large range of connectors for PMA conduits with the patented PMA safety clip system.

Connectors are available for degrees of ingress protection IP66 and IP68 according to IEC 60529. IP66 connectors are fitted with a pre-installed universal safety clip which ensures a quick “push-in” installation. IP68 connectors for increased requirements will be delivered with a special conduit seal cap.

The new PMAFIX IP68GT fittings combine simplest push-in assembly with highest sealing performance. It is also possible to upgrade to IP69 by retrofitting water impact protection.

Material

- Fittings made from specially formulated polyamide 6
- Threads made from nickel-plated brass or polyamide 6
- Self-extinguishing
- Free from halogens, REACH + RoHS compliant
- Very good chemical properties
- Temperature range: -40°C to +105°C, short-term to +160°C

Characteristics

- Excellent conduit pull-out strength
- High impact resistance
- Vibration-proof connection to PMA corrugated conduits
- Fits conduit profiles – fine (T) and coarse (G)
- To avoid accidental opening, disassembly is only possible with a screwdriver



Connector series

- 01 Serie N
- 02 Serie W
- 03 Serie B
- 04 Serie A
- 05 Serie O
- 06 Serie I
- 07 Serie Y
- 08 Serie T

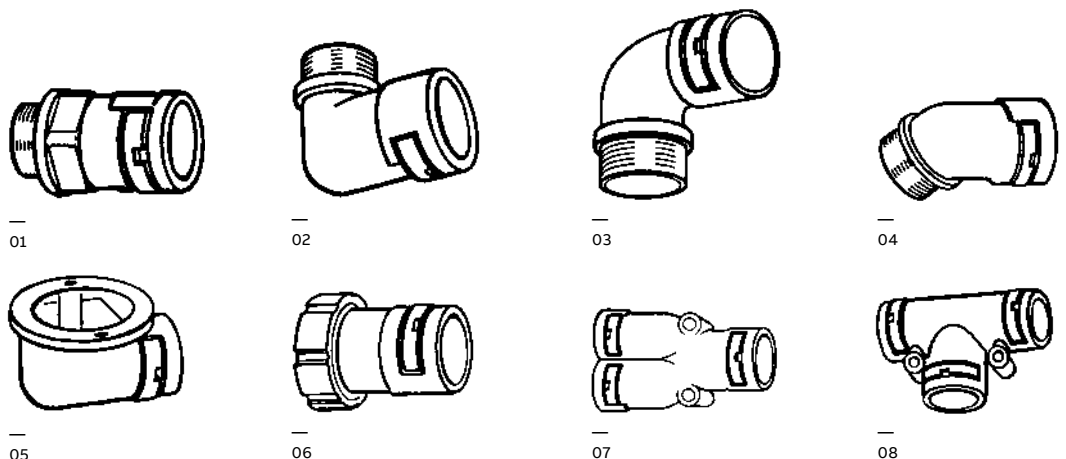

PMAFIX

General technical details

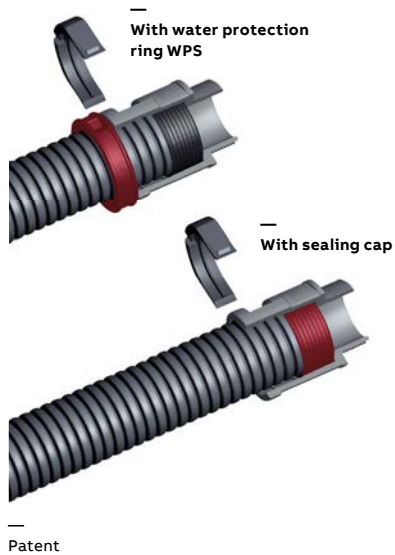

IP68

IP68, IP69 static

IP67, IP69 dynamic

- High sealing through additional seal cap
- For highest dynamic applications
- Additional water protection ring WPS for IP69 ingress protection in conjunction with the IP68 system to be applied right after the IP68 connector onto the conduit
- Content of delivery: Connector with sealing cap, safety clip and thread seal for male thread (O-ring and/or flat gasket)

IP68GT

IP68, IP69 static

IP67, IP69 dynamic

- The single piece PMAFIX IP68GT fitting with integrated sealing cap and pre-installed locking clip
- Simple push-in assembly (as with the proven PMAFIX IP66 system)
- The extra long sealing cap guarantees the highest level of ingress protection
- Identical approvals as for the PMAFIX IP68 system component version
- Fast modification of specification drawings through simple addition of "GT" to the existing order number (e.g. BVNV-M257 → BVNV-M257GT)
- Additional water protection ring WPS for IP69 ingress protection in conjunction with the IP68 system to be applied right after the IP68 connector onto the conduit
- Content of delivery: Connector with integrated sealing cap, pre-installed safety clip and thread seal for male thread (O-ring and/or flat gasket)

IP66

IP66 static

IP54 dynamic

- One piece fitting
- Conical sealing method
- Easy "push-in" installation
- Pre-installed safety clip AFN2
- Content of delivery: Connector with pre-installed safety clip

PMA EMC system for the rail industry

Providing electro-magnetic shielding



The PMA EMC System provides an additional function within the PMA Cable Protection System, offering high quality shielding against electro-magnetic signals over and above the mechanical cable protection.

The F.CK, F.CU and F.HY screening braids provide excellent shielding for electro-magnetic signals. The patented EMC fittings allow a low impedance 360° termination of the braid preventing stray signals and an earth connection via the termination thread, in addition to the standard water and dust tight termination.

PMAJACK Plastic and metal braids for the Rail industry

Bundle and protect electrical cables

Bundling and abrasion protection. Polyamide, polyester and steel braids – an alternative way to bundle and protect electrical cables.



Plastic braids manufactured from polyester and polyamide filaments – the other alternative solution for protecting and bundling cables.

This PMA cable protection system provides simple bundling and abrasion protection for cables and wires.

Various braid types to fulfill different requirements complimented by a range of braid terminations for simple and clean assembly.

Material

- Braids made from polyamide 6.6 or polyester
- Terminations made from PA 6, aluminium or brass
- Free from halogens, REACH + RoHS compliant

Characteristics

- Flammability of braids: Polyamide 6.6 UL 94 V2
- Braid design: Following DIN 65 164 part 1+2
- EN 45545-2 HL3
- NFPA 130 for 6.6 Braids

PMA Divisible System

General technical details



One-piece Divisible System. The ideal solution for repairs, retrofit and pre-loomed applications.



PMA offers a divisible system based upon PMA standard nominal widths. This allows free combination of the PACOF and PCOF divisible conduits with PMAFIX Pro, PMAFIX and PMA Smart Line fittings. Using the PMA Divisible System Fittings repairs can be easily made to existing installations without disconnecting cables. Equally all PMA conduits - also slit - are compatible with the fittings of the divisible system.



Special connectors and accessories for the Rail industry

Flexible and application friendly solutions

For flexible and application friendly solutions. PMA offers a vast array of practical accessories in order to complete the PMA cable protection system.

We offer lock nuts produced from polyamide or metal, thread reducers and enlargers, conduit adapters, swivel adapters as well as different mounting clips for conduits. All this practical products will help to create the PMA line for our customers even more flexible and application friendly.



Fire barrier solutions for the rail industry

For maximum safety

To fit all your requirements: Three flexible fire protection solutions, offering total planning and installation flexibility. As a leading global supplier of cable protection systems for use in rail applications, PMA has developed novel, innovative, EN 45545-3 compliant fire barrier solutions for combination with its proven cable protection Systems.

A PMA metal adapter is now available with built in intumescent material which can be used in combination with the standard range of PMA cable protection products approved for use in the rail industry. The adapters allow cables to be ducted through a fire wall without compromising the integrity and function of the fire wall. In the event of a fire the intumescent material swells to up to 40 times its original volume, sealing all cavities around and between the cables, preventing the propagation of fire and transport of smoke and gas along the cable protection system.

The adapters allow cables to be ducted through a fire wall without compromising the integrity and function of the fire wall. In the event of a fire the intumescent material swells to up to 40 times its original volume, sealing all cavities around and between the cables, preventing the propagation of fire and transport of smoke and gas along the cable protection system.

PMA fittings using strain relief cable clamping elements have been available for many years. Special fire resistant clamping elements are now available which when integrated into a PMA fitting provide a secure and effective barrier against fire, smoke and gas for up to 15 minutes.

PMA has also developed an adapter including intumescent material which can be built into a Roxtec sealing system. Roxtec sealing modules are well known and proven in rail and ship building construction for decades. The specially designed PMA adapter fits perfectly into a Roxtec module providing a sealed System.



PMA adapter solution

How the fire barrier works in a train

In the event of a fire, the intumescent material ensures that two areas remain separated from each other for at least 30 minutes (E30) in accordance with EN 45545-3. The intumescent material is fixed within the adapter to block the transport of fire, heat and fumes. The material is expanding to fill the cavities between the

cables within the adapter. Intumescent materials (typically sodium silicate or graphite) swell as a result of heat exposure to many times their original volume. The PMA adapters use this material very effectively to seal cavities preventing heat, fire and gases from passing through.

Without fire barrier: Fire and fumes can spread

In case of fire: Without a fire barrier, fire heat and fumes can immediately spread between the compartments and escalate the situation.



With PMA fire barrier: More safety and better prevention

The intumescent material within the PMA adapters swell in case of fire exposure and blocks transport of fire heat and fumes between the compartments or cabins up to 30 minutes in accordance to EN 45545-3.

In the event of a fire the intumescent material swells to up to 40 times its original volume, sealing all cavities around and between the cables, preventing the propagation of fire and transport of smoke and gas along the cable protection system. Giving valuable extra time to evacuate passengers and initiate the emergency plan.

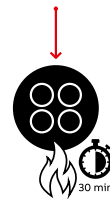

— Smartphone
for detailed
product
information.



Modular support system for conduits and cables

For use in rolling stock applications. The most versatile, compact and lightest design of its kind on the market.



PMA presents the new generation of modular support system for conduits and cables which redefine the state-of-the-art for rolling stock applications in terms of ease of installation, flexibility, lightness, durability and compactness.

Lightweight, compact with high impact resistance

BGPM is a lightweight, compact solution with high impact resistance. Thanks to the new design, external dimensions are reduced the very minimum and internal spacing between adjoining conduits is very small. The system is specifically designed for use in railway vehicle construction and other applications where fixation of parallel running conduits and cables is required.

Save up to 30% of installation time

Thanks to the modular system, up to 30% of installation time can be saved. Each element can hold different combinations of both, conduits and cables in various sizes. Multiple conduits and cable in various sizes can be clamped in one element which is then secured with only two screws.



Quick and user friendly installation

The new modular support system offers total flexibility in terms of installation complying with all kinds of installation requirements. Each element can host different combinations of both conduits and cables, in various and different sizes, so that cable routing is made easy regardless of its complexity. Furthermore the fixation of the modular support system can be done with different techniques: on a C-rail, pre-assembled, stacked or upside-down.

Conduit rotation possible, preventing torsion

The single rib fixation provides a high axial retention force and compatibility with both coarse and fine profile conduits. Conduits are able to rotate in the fixation preventing torsion stresses to conduits in moving systems.

The BGPM is compatible with all PMAFLEX, PMAFLEX Pro and PMA Smart Line conduits.

Your key benefits with the BGPM:

- Light weight, compact design
- High impact resistance
- Quick installation, possible with one hand
- Conduit rotation possible, preventing torsion
- Axial fixation of conduit and/or cables
- Pre-assembly possible for the bottom half of the support by clips
- Reduction half shell for conduits of smaller size
- Clearance holes for M6 threaded screws for fixation
- Use of Allen-screws and hexagonal-head-screws possible

Multilayer solutions for the rail industry

Improved performance and safety



Our new innovative railway engineering multilayer product line provides protection and safety for cables on intercarriage jumper connections, bogies, roof installations and under-carriage installations.



The new PMA multilayer technology allows combinations of materials for optimal product characteristics in rail applications. An innovative multilayer manufacturing technology creates a corrugated conduit with two layers of material. This multilayer solution provides additional protection and safety thanks to the combination of two specially modified polyamides with different material characteristics. The new material combinations significantly improve the overall performance of the conduits.

To meet all customers' application requirements and provide full planning flexibility, PMA offers two different multilayer solutions for the rail industry:

- The very flexible **XPCS conduit** with green inner layer meets EN 45545-2, HL2 according to requirement set R22 and NFPA 130 allowing use in external dynamic applications such as, roof installations, inter-carriage jumper cables, undercarriage and bogies.
- The highly flexible **XPCSF conduit** with orange inner layer meets the highest classification of EN 45545-2, HL3 according to requirement set R22 allowing use in external dynamic applications such as, roof installations, inter-carriage jumper cables, undercarriage and bogies on all train design categories and any operation category.
- The flexible heavy-duty **XVCSF multilayer conduit** with blue inner layer, meets EN45545-2, HL2 according to requirement set R22 and NFPA 130 and is suitable for use in rail static external applications such as under carriage, bogies etc.

The key benefits:

- Excellent resistance to UV and weathering
- Outstanding ageing characteristics.
- Wear indication through coloured inner layer

A new standard in comprehensive end-to-end cable protection solutions

Together with PMA's tried and tested product range of fittings and accessories in various sizes, the XPCSF, XPCS and XVCSF conduits with new state-of-the-art multilayer technology offer a comprehensive and sustainable end-to-end cable protection solution for the rail industry.



XVCSF Multilayer conduit

The XVCSF multilayer conduit with blue inner layer is suitable for use in rail static external applications such as under carriage, bogie, etc.



XPCSF Multilayer conduit

The XPCSF multilayer conduit with orange inner layer is suitable for use in all external rail rolling stock applications.



XPCS Multilayer conduit

Conduit with green inner layer for external applications on railway vehicles.

PMA's tested and certified excellence in cable protection

Intensive testing, research and development activity is a top priority at PMA every day. That's why PMA is a market leader in the field of cable protection.

PMA cable protection from ABB are used globally, extensively in many areas and applications. The level of protection we have to offer to cables is constantly increasing. Extensive testing is therefore critical for research and development of new cable protection products as well as in quality control. Our products are tested to both international standards and internal test procedures. The internal PMA procedures are designed to supplement the international standards simulating real applications, testing to destruction finding the real limits of the product.

PMA cable protection delivers innovative, customised solutions that aim to streamline

testing processes:

- Product development based on market needs
- Two in-house test laboratories (Uster and Coleshill)
- Broad range of available test installations
- Intensive product quality testing over specified periods

Our rigorous testing process helps ensure that your products align with all applicable requirements and expectations. To the extremes of cold to the extremes of heat and humidity. Our global team's knowledge helps to stay ahead of requirements, materials and technologies. It gives our customer the confidence that our products perform without failure or problems, meet their expectations and all regulations.

Customers' application-specific needs are a top priority at PMA. That's why PMA has more than 15 test procedures ("PMA DO") that enables us to perform cable protection-related, application-specific material and product tests.



PMA Cable Protection

Test videos

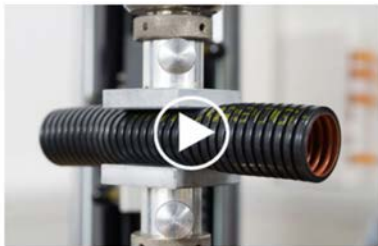

PMA Test
Compression Strength



PMA Test
Resistance to Impact



PMA Test
Flexibility at Low Temperature



PMA Test
Resistance to Fatigue when Exposed to Continuous Bending 2



PMA Test
System Security – Pull-Out Strength



PMA Test
Ingress Protection for Static Applications



PMA Test
Resistance to Thermal Ageing



PMA Test
Flammability Tests



PMA Test
Flammability Test – Limited Oxygen Index



PMA Test
Resistance to Fatigue when Exposed to Continuous Bending



PMA Test
Ingress Protection for Dynamic Applications



PMA Test
Resistance to Chemicals



—
Smartphone for detailed product information.



Cable Protection
you can trust

Tested and certified
under harsh conditions

PMA provides efficient custom made cable protection systems for the Rail industry. Our high quality products have been tested and certified to provide practical, cost effective solutions. In this way PMA has become a reliable partner around the world for rail manufacturers. www.pma.ch

PMA

ABB

Further information

Visit our website

Visit the PMA product web pages on pma.ch for our most up-to-date product lineup, and much more. This is the place to go to find all of the planning documents you need at your fingertips, including:

- Technical data sheets
- General technical details
- CAD files
- Brochures
- Application recommendations
- White paper
- Latest new and updates
- Videos





ABB Switzerland Ltd.

PMA Cable Protection
Aathalstrasse 90
CH-8610 Uster
Phone +41 58 585 00 11
pma-info@ch.abb.com

www.pma.ch
new.abb.com

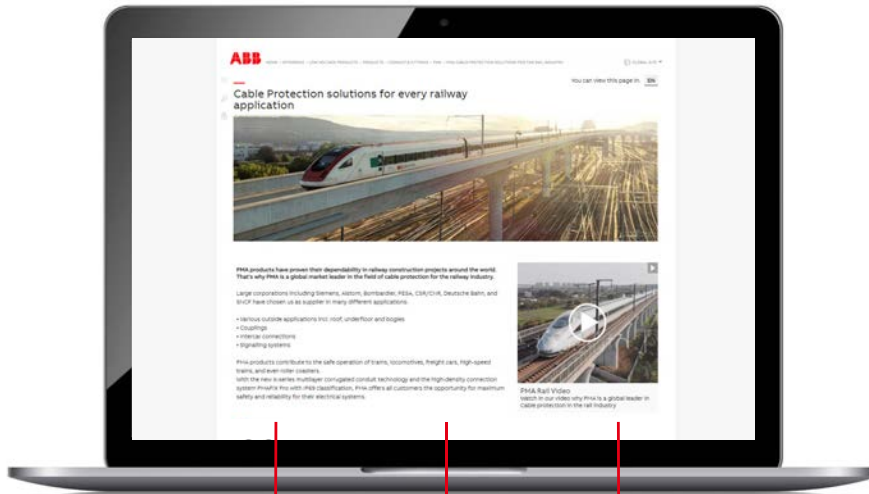
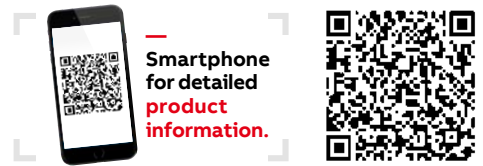

Autoryzowany dystrybutor

ASTE Sp. z o.o.

Kowale, ul. Magnacka 25, 80-180 Gdańsk

tel.: 58 340 69 00

e-mail: aste@aste.pl, www.aste.pl

